

PDA3400

Internally Mounted Plastic NEMA 4X Enclosures for 1/8 DIN Digital Panel Meters



Download free 3-D CAD files of these enclosures to simplify your drawings!

predig.com/documentation-cad

PDA3407 Enclosure Shown with a ProVu Meter and MOD-LH Light / Horn and Reset Button.
Meter & MOD-LH Sold Separately. Assembly Required.



FEATURES

- House up to 3 Meters
- Plastic
- 1/8 DIN and 1/4 DIN cutouts available
- Meter Mounted Behind Clear Cover
- NEMA 4X
- Mounting Hardware Provided
- UL, C-UL Listed
- Light / Horn & Reset Button
- Pipe Mounting Kit Options

OVERVIEW

The PDA3400 series of internally mounted plastic NEMA 4X enclosures for 1/8 DIN Digital Panel Meters and 1/4 DIN PID Controllers provide a convenient way to mount one, two or three Precision Digital meters to walls and other vertical structures. The PDA3400 series enclosures provide a greater degree of protection than other Precision Digital enclosures because the meters are mounted behind a clear polycarbonate cover. These enclosures also have room for a light / horn accessory. They also come pre-cut with 1/8 DIN or 1/4 DIN cutouts or they can be ordered with no cutouts / front plate. Mounting hardware is provided. The cover is secured with four screws. Optional pipe mounting kits are available for mounting the enclosures to 2" pipes. Enclosures, meters and accessories are ordered and packaged separately.

PDA3400 Internally Mounted Plastic NEMA 4X Enclosures

WALL MOUNTING

The PDA3400 enclosures include four mounting flanges and four screws. Using the included screws and a Phillips head screwdriver simply assemble each flange in the four threaded screw holes on the back of the enclosure as shown in the example below.



Front view of a PDA3400 series enclosure with supplied mounting flanges installed



Rear view of a PDA3400 series enclosure with supplied mounting flanges installed



The PDA3400 series enclosures is supplied with 4 screws and 4 mounting flanges

ENCLOSURE SELECTION UTILITY

This utility simplifies the selection process of the right enclosure for your application based on the number and type of meters to be installed in the enclosure.

STEP 1. Select number of meters

Step 1:

How many meters do you need to house?

Finished assembly of these enclosures is done at the time of the order. As such, acknowledged orders are non-cancelable and the product is non-returnable.

STEP 2. Select cutout configuration

Step 2:

Please use the graphics below to select the cutout configuration for your 4 Precision Digital products

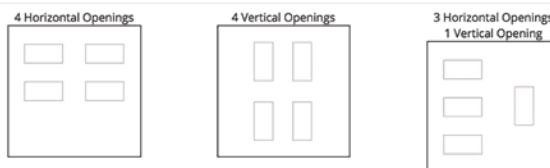

STEP 3. Select type of meters

Step 3:

Select which type of meter you will be installing into the enclosure.

You can view more details about a particular product by moving your mouse over the pictures below.



STEP 4. Choose from results

Enclosure Selection Utility Results

SKU	Description	Stock	Lead Time	Price
PDA2304	PDA2300 Series NEMA 4X Plastic Enclosures Enclosure Cutouts: Four (4) Material: Plastic Meter Mounting: Through front panel Orientation: Horizontal Warranty: 1 year Approvals: UL/C-UL	3	3 business days	\$269.00
PDA2504	PDA2500 Series Plastic NEMA 4X Enclosures Enclosure Cutouts: Four (4) DIM Size: 1/8 DIN Material: Plastic Meter Mounting: Through front panel Orientation: Horizontal Warranty: 1 year Approvals: UL/C-UL	1	13 business days	\$349.00
PDA2604	PDA2600 Series Stainless Steel NEMA 4X Enclosures Enclosure Cutouts: Four (4) Material: Stainless Steel Meter Mounting: Through front panel	1	33 business days	\$859.00



Need help selecting the right enclosure?
www.predig.com/esu

PDA3400 Internally Mounted Plastic NEMA 4X Enclosures

MODELS AVAILABLE

Cutouts



PDA3407



PDA3408



PDA3411



PDA3412



PDA3414

No Cutouts



PDA3412-B

MOUNTING A METER INSIDE THE PDA3400 ENCLOSURE

1. Mount the panel meter by placing it through the cutout on the mounting plate. Secure the meter with the mounting brackets included with the meter.

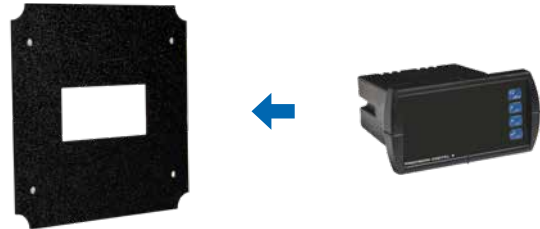

2. Take the mounting plate with the meter and screw it onto the enclosure box by lining up the four screw holes on the plate to the four mounting rods shown on the inside of enclosure.

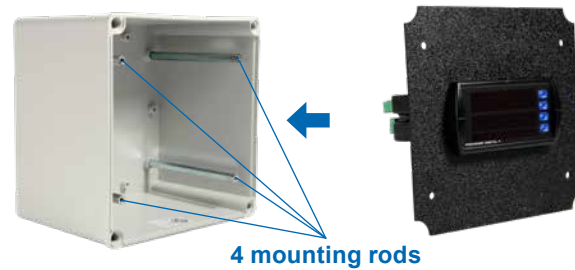

3. Screw the clear cover onto the front of the enclosure using the four white plastic screws included with the PDA3400.

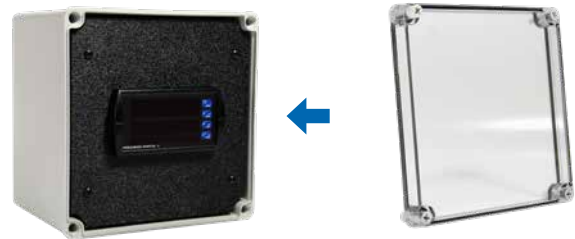

Fully assembled meter in enclosure

Side view showing meter under clear cover



Need help selecting the right enclosure?
www.predig.com/esu

PDA3400 Internally Mounted Plastic NEMA 4X Enclosures

ACCESSORIES

PDA3400 Series Enclosure with Light / Horn

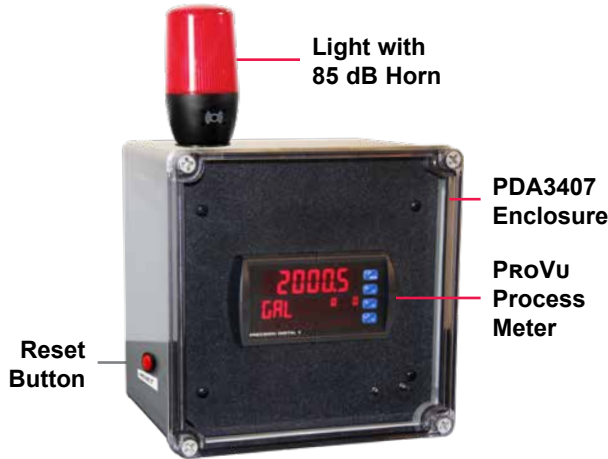

Light / Horn Accessories

Precision Digital offers a Light / Horn that can be mounted to the PDA3407 and PDA3408 by the user. This Light / Horn can be wired to flash or stay steady on and the horn is rated at 85 dB. The light and horn can be controlled independently of each other via separate relays on the meter such that the horn can be programmed to silence via a button mounted to the enclosure and the light can be programmed to stay on until the alarm clears.

The light / horn and reset button are all rated NEMA 4X or IP65. The following table illustrates a typical way the Light / Horn accessory can be wired and programmed using the four relays on the ProVu meter:

Relay #	Connected to	Typical reset method (user selectable)
1	Flashing Light ⁽¹⁾	Auto reset
2	Horn	Silence with Reset Button at any time
3	User Device	As user desires
4	User Device	As user desires

1. Light can be wired to flash or stay steady on

Notes:

- The Light / Horn accessory is powered from the 200 mA transmitter power supply; so when it is installed, there is less power available for the transmitter. See MOD-LH and MOD-LHX2 Series instruction manuals for details.
- See LIMMODLHX2 for typical wiring diagrams using the Trident X2 meter, which has a capacity of only two relays.

MOD-LH & MOD-LHX2 Light / Horn Accessories

When these are ordered, the enclosure comes pre-drilled with holes for the Light / Horn and Reset Button to be installed by user. Meter and enclosure are sold separately. The Light / Horn hole is in the back left corner of the enclosure and the Reset button is centered on the side of the enclosure about an inch off the bottom. For mounting in different locations, order items separately and drill holes and mount as desired. Other light and button colors are available.

Light / Horn Dimensions

Units: Inches (mm)

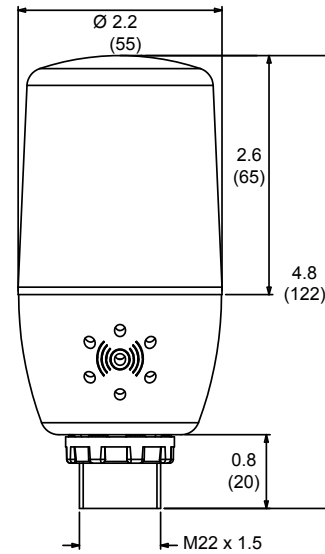

PDA6545 2" Pipe Mounting Kit

The PDA6545 and PDA6545-SS pipe mounting kits provide convenient ways to mount the PDA3400 enclosures to 2" pipes.



PDA-SSTAG Stainless Steel Tags

PDA-SSTAG is a laser etched stainless steel tag accessory for any of your Precision Digital meters. The tag features custom text for equipment identification, instruction, or whatever else is needed in your facility. Each tag comes with a stainless steel wire and lead seal for easy mounting wherever you need it.



PDX18DIN-FILLER 1/8 DIN Cutout Filler

The NEMA 4X 1/8 DIN cutout filler is used to cover up empty 1/8 DIN cutouts and maintain the NEMA 4X rating to the panel or enclosure. It consists of a generic bezel with a black faceplate, as well as mounting brackets, gasket, etc.



PDA3400 Internally Mounted Plastic NEMA 4X Enclosures

SPECIFICATIONS

General

Material: Plastic
Color: Body: Gray; Cover: Clear polycarbonate plastic
Meters: Houses up to 3 meters
Meter Mounting Method: Behind clear window
Cover Mounting Method: Screws
Ratings: NEMA 4X
Approvals: UL, C-UL
Operating Temperature: -40 to 120°C
Warranty: 1 year

1/8 DIN Meter Types

Type	Meters
B	PD542, PD543, and PD562
C	PD603, PD644, PD743, PD765, PD6602, PD6603, PD6604, PD6606, PD6607, PD6608, PD6622, PD6624, and PD6626, and PD6628.
D	PD138, PD154, and PD158
E	PD6000, PD6001, PD6060, PD6080, PD6081, PD6088, PD6089, PD6100, PD6200, PD6210, PD6262, PD6300, PD6310, PD6310-WM, PD6363, PD6400, and PD7000

Dimensions / Features

• Available ■ 1 Required

Model	# of Meters	1/8 DIN Meter Type				DIN		Outside Dimensions (H x W x D) Inch (mm)	Inside Dimensions (H x W x D) Inch (mm)	Mounting Dimensions Inch (mm)	Conduit Hole	Fits PDA 1024-01	Fits Light / Horn	Weight lb (kg)			
		B	C	D	E	1/4	1/6										
Horizontal Cutouts																	
PDA3407	1	•	•	•	•			7.9 x 7.9 x 6.3 (201 x 201 x 160)	7.5 x 7.5 x 5.0 (190 x 190 x 127)	7.125 x 9.75 (181 x 248)			•	3.1 (1.4)			
PDA3408	1					•											•
PDA3411	2	•	•	•	•												
PDA3412	3	•	•	•	•												
PDA3414	2	•	•	■	•												
No Cutouts																	
PDA3412-B	N/A							7.9 x 7.9 x 6.3 (201 x 201 x 160)	7.5 x 7.5 x 5.0 (190 x 190 x 127)	7.125 x 9.75 (181 x 248)			•	3.1 (1.4)			

DIMENSIONS

Units: Inches (mm)

All Enclosures

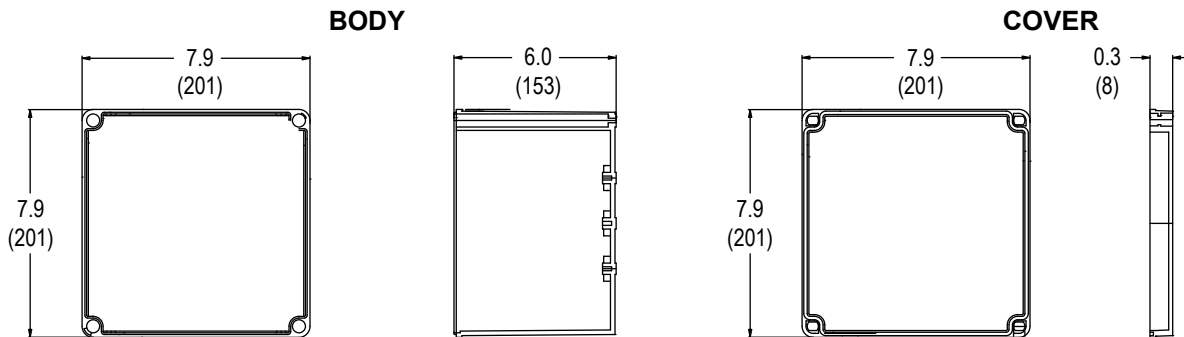

Dimensions for: PDA3407, PDA3408, PDA3411, PDA3412, PDA3412-B, PDA3414.



Download free 3-D CAD files of these enclosures to simplify your drawings!

predig.com/documentation-cad

PDA3400 Internally Mounted Plastic NEMA 4X Enclosures

ORDERING INFORMATION

Horizontal Cutouts

Model	# of Meters	1/8 DIN Meter Type				DIN	
		B	C	D	E	1/4	1/16
PDA3407	1	•	•	•	•		
PDA3408	1					•	
PDA3411	2	•	•	•	•		
PDA3412	3	•	•	•	•		
PDA3414	2	•	•	■	•		

• Available ■ 1 Required

1/8 DIN Meter Types

Type	Meters
B	PD542, PD543, and PD562
C	PD603, PD644, PD743, PD765, PD6602, PD6603, PD6604, PD6606, PD6607, PD6608, PD6622, PD6624, and PD6626, and PD6628.
D	PD138, PD154, and PD158
E	PD6000, PD6001, PD6060, PD6080, PD6081, PD6088, PD6089, PD6100, PD6200, PD6210, PD6262, PD6300, PD6310, PD6310-WM, PD6363, PD6400, and PD7000

No Cutouts

Model	Description
PDA3412-B	Enclosure with no Cutouts

Accessories

Model	Description
MOD-LHRB1	Red ⁽³⁾ Light / Horn + Reset Button with Holes Drilled ⁽¹⁾ (PROVu)
MOD-LHRB1-X2	Red ⁽³⁾ Light / Horn + Reset Button with Holes Drilled ⁽¹⁾ (Trident X2)
PDA-BUTTON1R	Red ⁽³⁾ Reset Button ⁽²⁾
PDA-LHR	Red ⁽³⁾ Light / Horn
PDA6545	2" Pipe Mounting Kit, Zinc Plated
PDA6545-SS	2" Pipe Mounting Kit, Stainless Steel
PDA-SSTAG	Stainless Steel Tag
PDX18DIN-FILLER	1/8 DIN Cutout Filler

1. The enclosure comes pre-drilled with holes for Light / Horn and Reset Button to be installed by user. Meter and enclosure are sold separately. The Light / Horn hole is in the back left corner of the enclosure and the Reset button is centered on the left side of the enclosure about an inch off the bottom. For mounting in different locations, order items separately and drill holes and mount as desired.

2. The Reset Button works only with meters that have digital input contacts.

3. For other color options see corresponding instruction manual.

⚠ WARNING

Cancer and Reproductive Harm - www.P65Warnings.ca.gov



Need help selecting the right enclosure?
www.predig.com/esu



Download free 3-D CAD files of these enclosures to simplify your drawings!

predig.com/documentation-cad



Your Local Distributor is:

Disclaimer

The information contained in this document is subject to change without notice. Precision Digital Corporation makes no representations or warranties with respect to the contents hereof, and specifically disclaims any implied warranties of merchantability or fitness for a particular purpose.

©2010-2019 Precision Digital Corporation. All rights reserved.

LDS3407-14_H 11/19